

# resistance welding

# ISA Series Mid-Frequency Inverter Resistance Welding Control

- 500, 1000, 2000 & 4000 Amp Primary Output
- Five Feedback Modes
- Built-in Current, Voltage, Power and Time monitor
- Pre-weld Check Process Tool
- Set Monitor Hi/Low limits
- Comprehensive Machine I/O
- Communication Options
- NEMA style enclosures



## Applications

- Automotive sheet metal and components
- Stainless and galvanized doors and furniture
- High-speed bi-metal contact welding
- Storage Batteries
- Aircraft components (aluminum and titanium)
- Nut welding
- Projection welds
- Motor armature fusing
- Markless welding
- Heavy gauge shelving and wire welds
- Copper wire fusing
- Aluminum structure welds
- Welding of advanced steels (dual phase, TRIP, Martensitic, etc.)
- Appliance sub-assemblies

## Features

- **Closed loop technology**  
Inverters produce consistent, reliable welds with optimal nugget formation, superior joint strength and excellent surface appearance.
- **Fine heat input control**  
Short weld times and millisecond control provide more accurate welds, resulting in a smaller heat affected zone (HAZ), and facilitating longer electrode life than conventional AC welding technology. Markless welding also becomes possible.
- **Control mode flexibility**  
Select which mode fits the application, with fast rise times for conductive material or finer control for resistive material. Constant Power feedback mode helps to break up surface oxides and extends electrode life, especially when welding coated steels or aluminum.
- **Reduce operating costs**  
Inverters draw less energy from the incoming power line than single phase AC welders. This leads to greater cost savings and power efficiency in today's modern manufacturing plants.
- **Automation-ready**  
Inverter transformers are smaller than AC transformers, making them well suited for automation and robotics.
- **Process control**  
The ISA's stable welding control and built-in monitoring deliver wider process windows and traceability, and fulfill documentation requirements for many of today's industries.
- **Improve weld reliability**  
Inverters have greatly reduced secondary inductive losses, which eliminate many welding problems associated with AC welding technology.

*Spirit Of Innovation™*  
**MIYACHI  
UNITEK™**

## STEPPER & ADVANCED FUNCTIONS

The ISA Series inverters have sophisticated steppers for varying the heat delivered to the weld over multiple welding sequences. Users who are familiar with their electrode wear and oxidation cycles are able to further increase the time between routine electrode maintenance by taking advantage of the advanced stepping functions. The ISA is able to execute up to nine steps in a single sequence with user programmable step counts. Steps can be a fixed percentage heat increase or decrease after a certain number of welds or can be a linear increase or decrease over a number of welds. Users can request linear or fixed step.

STEPPER OFF	VALVE	1	SCHEDULE	#000	
STEP	%HEAT	TD	STEP	%HEAT	TD
1	0000	100	6	0000	100
2	0000	100	7	0000	100
3	0000	100	8	0000	100
4	0000	100	9	0000	100
5	0000	100			0000

Steps can be programmed on the MA-627 Programming Pendant or programmed remotely in WeldLab software and sent to the control via RS-485.

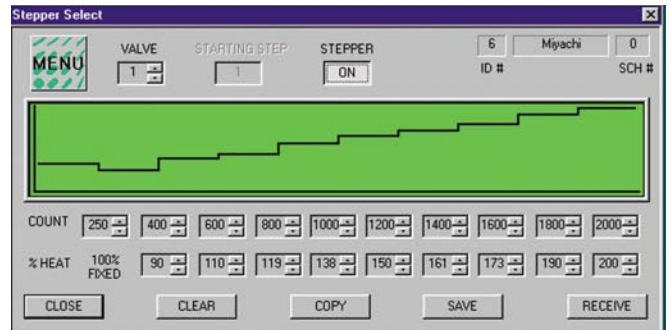

**Fixed Step Routine**

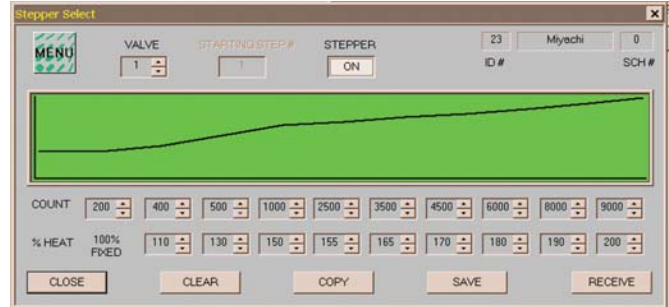

**Linear Step Routine**

## NETWORKING, REMOTE PROGRAMMING

The ISA Series can be fully equipped with two-way Ethernet or RS-485 communication protocol. Users can send remote commands to the control and collect weld data. Up to 30\* ISA welding controls can be connected to a network host computer. The Miyachi Unitek Weldlab and Weldnet software accomplishes multiple remote programming and data collection functions that include:

- Remote schedule programming
- Error detection and notification
- Data collection and export to Excel®
- Stepper sequence programming
- Menu mode changes
- Valve programming

\*Maximum number determined by application.



**Remote programming**



**Network welder status**

## ISA INVERTER WELDING CONTROLS

The ISA Series consists of an inverter control packaged in a “NEMA” style cabinet, a versatile programming pendant (optional additional monitoring pendant) and a range of matched transformers optimized for total system performance and efficiency. Programming is simple: the user can set up to 64 weld schedules containing dual pulse welding profiles with upslope and downslope control. Time can be programmed in cycles or millisecond increments. Other key features include:

- Chaining, successive and spot welding modes
- Squeeze delay, squeeze, cool and hold
- Forge delay programming
- Constant current and constant power feedback modes, fixed pulse open loop mode
- Flexible stepper functions (including linear stepper option)
- Monitoring limits – current / voltage / power / pulse width
- Nine programmable impulses for temper sensitive materials such as high strength steels

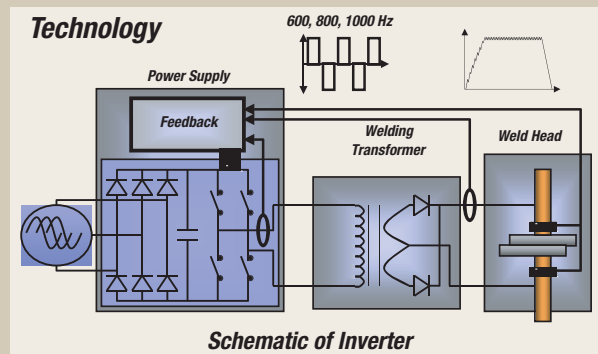

## FEEDBACK MODES

**Primary Constant Current RMS** – acquires feedback from a primary internal sensor.

**Primary Limit** – acquires feedback from a primary internal sensor. Fastest rise time.

**Secondary Constant Current RMS** – acquires feedback from a secondary coil. Most accurate control of current and response to weld dynamics.

**Secondary Constant Power RMS** – acquires current feedback from a secondary coil and voltage feedback from the voltage drop across the electrodes. Useful for coated steels, aluminum and oxidation problems, extends electrode life.

**Fixed Pulse** – allows the pulse width to be fixed for a constant primary output.

## APPLICATION OF TECHNOLOGY

### Constant Current

- Delivers the same current regardless of resistance changes
- Compensates for part thickness changes
- Programmable upslope for round parts or to reduce splash and marking
- When welding in constant current, monitor voltage and power

### Constant Power

- Precisely varies the current and voltage to achieve consistent energy
- Breaks up surface contaminants, oxides and plating
- Ideal for automation, extends electrode life
- When welding in constant power, monitor current and voltage

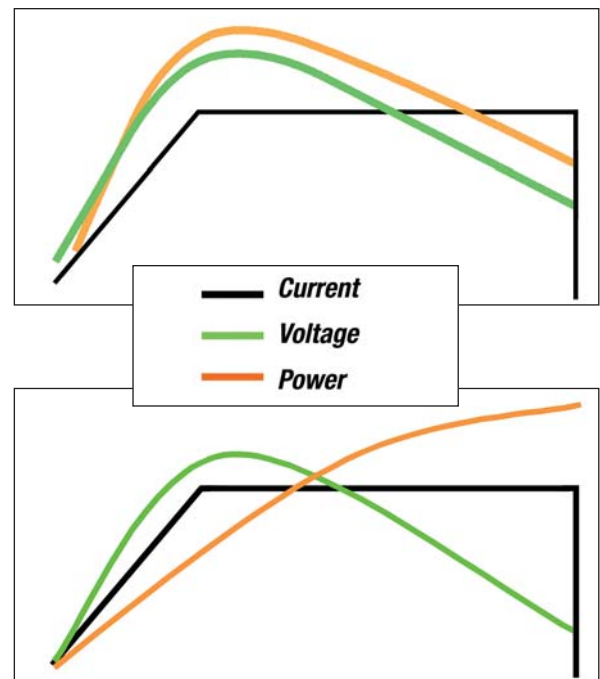

Representation of energy waveforms for wire-to-wire weld.

## DESIGNED FOR RELIABILITY & PERFORMANCE

### Inside the ISA...

The ISA Series is designed to perform in the harshest of production environments. Inside the "NEMA" style cabinet the power supply layout is logically designed in a modular fashion and manufactured to the highest quality standards. Key features are as follows:

**Accessory Mounting** – Space has been allowed in the design to accommodate PLC controls and ancillary devices for automation purposes.

**I/O** – All I/O is labeled and located on a single terminal strip. Device Net I/O and other interfaces can also be provided.

**Robustness** – Miyachi products are well respected within all types of manufacturing industries for their durability and robust performance over time, a reputation that is well deserved and valued by our customers.

**Reliability** – Miyachi controls are designed with reliability in mind. Component selection and unit testing is completed to the highest standards, ensuring years of trouble-free service.

**Easy Maintenance** – With ease of maintenance in mind, the ISA series was designed with modules that perform specific tasks. Each module can easily be extracted with minimal fasteners and quick-disconnect wire harnesses. Any module can be changed in less than 7 minutes. Given this unique design, down time is minimized.

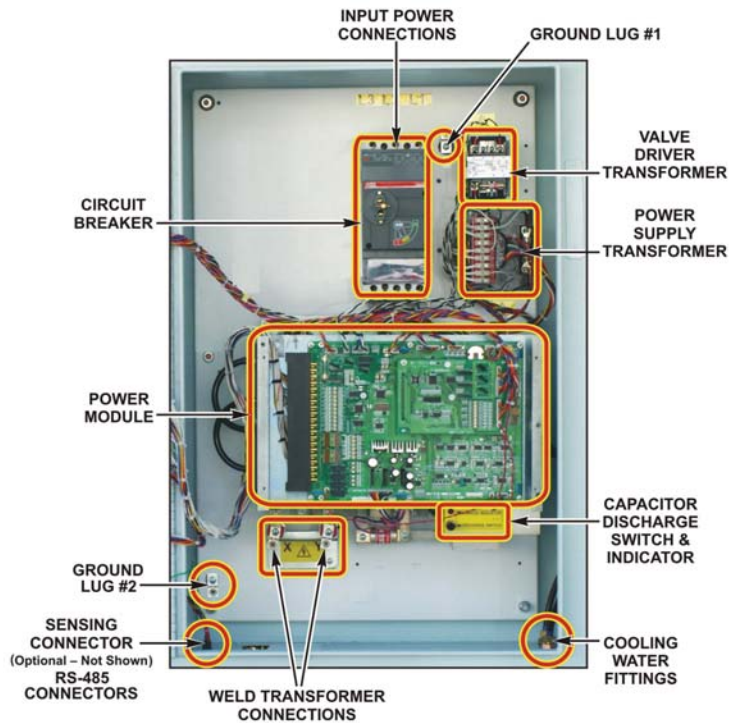

*ISA Build Quality and Design Excellence*

## PROGRAMMING MADE EASY

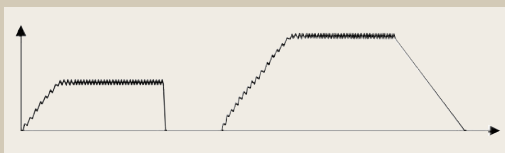

### Precise energy delivery...

The ISA Series provides the user complete flexibility in waveform programming. All time periods can be programmed in either millisecond or cycle increments. Single or dual pulse waveforms with upslope and downslope can be tailored to the needs of the application.

Unlike traditional AC welding controls, inverter waveforms have no off time during the welding pulse. Precise programming of upslope and weld time provides a greater degree of control over the heating rate of the materials. This can help prevent splash and expulsion and promotes controlled weld nugget growth without weld voids or cracking.



*MA-627 Programming Pendant and MA-628 Monitor unit.*

**MA-627A Remote Programming Pendant** – Used to store weld schedules and program multiple inverter controls.

**MA-628A Monitor Unit** – Adds process security by displaying Current, Time, Error data, and Stepper status while inhibiting access to programming.

## PROCESS TOOLS

**Pre-Weld Check** – The ISA inverter allows the user to program a low energy current pulse prior to the main welding pulse; the voltage of this first pulse can be monitored and limits applied. As the current is constant, the voltage represents the resistance during the check pulse. Limits allow the unit to detect the following:

- Missing parts
- Material changes or misalignment

**Pulse Width % Limit** – To develop weld current, the inverter outputs pulses of a constant voltage to the primary of the weld transformer. To increase or decrease current, the inverter increases or decreases the width of its output pulses (commonly known as PWM or “Pulse Width Modulated”). As the resistance on the secondary circuit increases, the pulse width also increases. Given that limits can be set around the percentage of pulse width, the degree of secondary resistance can be monitored. If the secondary degrades or fails, or there is a drastic weld material change, the ISA will give an alarm.

**Current, Voltage, Power and Time Monitoring** – The ISA’s built-in monitor keeps track of weld power and time variables. These are key, as they reflect the changes in resistance from weld to weld. Monitor results are displayed on the MA-627A program pendant, or data can be sent from the ISA via RS-485 for every weld and can be collected from multiple controls in a network. The Miyachi Unitek WeldLab™ software facilitates two-way communication between a host computer and welding controls for welder program changes and weld data acquisition.

```

-MONITOR          SCHEDULE # 01
  TIME CURR  VOLT POWER  PULSE
WELD1 010ms 01.8kA 0.87V 01.6kW 26.1%
WELD2 020ms 05.2kA 2.21V 11.5kW 56.4%
  VALUE1 VALUE2
STEPPER COUNT 0000 0000 WELD COUNT 00
STEP #        1      1
    
```

```

-MONITOR          SCHEDULE # 01
  TIME CURR  VOLT POWER  PULSE
WELD1 010ms 02.1kA 0.50V 01.1kW 22.1%
WELD2 020ms 05.8kA 1.27V 07.4kW 42.9%
  VALUE1 VALUE2
STEPPER COUNT 0000 0000 WELD COUNT 00
STEP #        1      1
    
```

```

-MONITOR SET      SCHEDULE # 001
  CURRENT  VOLT  POWER  PULSE
WELD1 HIGH 02.0kA 1.00V 09.9kW 080%
WELD1 LOW  01.4kA 0.60V 00.0kW
WELD2 HIGH 05.9kA 1.80V 08.9kW 090%
WELD2 LOW  05.3kA 1.30V 08.0kW
    
```

Monitor display screens with programmable limits for:

- Current
- Voltage
- Power
- Pulse Width

## POWER SAVINGS & EFFICIENCY

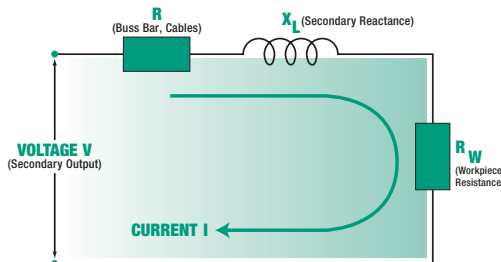

Power Savings and Efficiency – With AC controls, secondary reactance becomes a factor. Secondary energy is lost through  $X_L$ . With inverter controls, the effect of  $X_L$  is greatly minimized.

The ISA inverter power supply is an extremely efficient and cost effective control as compared to traditional AC welding controls. Given the characteristics of AC controls, energy is lost due to decreased power factor and higher secondary impedance. The inverter power supply draws its power from a three-phase input and therefore has a balanced primary current draw on the supply. Shorter weld times and lower welding energy also contribute to reductions in electrical usage and expense. Being that the output of the inverter is DC, secondary losses are minimized. Users of multiple welding controls have found that the savings in running costs of inverters compared to traditional AC technology can be a significant factor.

## FORCE CONTROL

One of the most important variables in the weld process is force control. Incorrect force can result in hot or cold welds. Worse yet, low force can result in material expulsion. The ISA control can be ordered with an option to allow electronic programming of force via an Electronic Pressure Regulator.

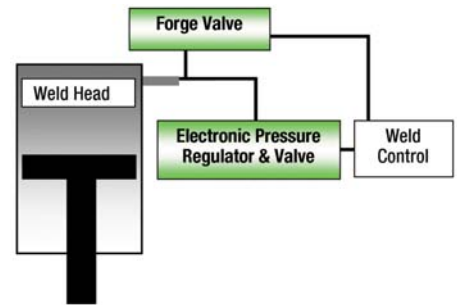

- **Electronic Pressure Regulator** – Force can be programmed as part of a weld schedule. The ISA will output a 0 – 10 volt signal to an electronic pressure regulator. The electronic regulator will control the pressure to the cylinder and, therefore, weld force is controlled as part of the weld schedule.
- **Forge Force** – The ISA standard control has a programmable “Forge Delay” which allows the user to program a delay at which to apply additional forging force via a separate valve assembly. Forge force is useful when welding aluminum.

```

-PAGE UP
-SCHEDULE #001
VALUE # 1
FORGE VALVE # 2 FORGE DELAY 0060ms
TURNS RATIO 050.0
CHAINING OFF
SUCCESSIVE OFF
WELD ON/OFF ON
    
```

## SPECIFICATIONS

	ISA - 500CR	ISA-1000CR	ISA-2000CR	ISA-4000CR
<b>Rated Capacity (480VAC)</b>	182 kVA	325 kVA	650 kVA	1250kVA
<b>Maximum Primary Output Current (Peak)</b>	500A @ 15% duty cycle	1000A @ 12% duty cycle	2000A @ 12% duty cycle	4000A @ 12% duty cycle
<b>Settings – Constant Current</b>	2.0-40.0 kA	4.0 – 80.0 kA	8.0 – 160.0 kA	32.0 – 200.0 kA
<b>Constant Power</b>	2.0-60.0 kW	4.0 – 80.0 kW	8.0 – 160.0 kW	15.0 – 300.0 kW
<b>Fixed Pulse</b>	10.0-99.9%	10.0-99.9%	10.0 – 99.9%	10.0 – 99.9%
<b>Weld Monitors – Current</b>	00.0-40.0 kA	00.0-80.0 kA	000-160 kA	000.0 – 200.0 kA
<b>Voltage</b>	0.00-9.99 V	0.00-9.99 V	0.00-9.99 V	0.00 – 9.99 V
<b>Power</b>	00.0-99.9 kW	00.0-99.9 kW	000.0-160.0 kW	000.0-300.0 kW
<b>Pulse Width</b>	10-100 %	10-100%	10-100%	10-100%
<b>Power Source</b>	3 phase 230, 380, 400, 415, 480, 575 VAC +10% / -15% 50/60 Hz. Other voltages available on request			
<b>Output Frequency</b>	1 kHz/800 Hz/600 Hz (Selectable)			
<b>Control Systems</b>	Primary Constant Current ( RMS ) Primary Constant Current ( Peak ) Secondary Constant Current Secondary Constant Power Fixed Pulse			
<b>Number of Weld Schedules</b>	64			
<b>Time Settings</b>	<b>Squeeze Delay</b>	0000-9999ms / 000-999cyc		
	<b>Squeeze</b>	0000-9999ms / 000-999cyc		
	<b>Upslope 1</b>	000-400ms / 00-20cyc		
	<b>Weld 1</b>	000-600ms / 00-30cyc		
	<b>Cool</b>	000-999ms / 00-99cyc		
	<b>Weld 2</b>	000-600ms / 00-30cyc		
	<b>Downslope 2</b>	000-400ms / 00-20cyc		
	<b>Hold</b>	000-999ms / 00-99cyc		
	<b>Off</b>	0000-9990ms / 00-99cyc		
<b>Impulses</b>	1-9			
<b>Forging</b>	Programmable Delay Time			
<b>Modes</b>	Chaining, Successive, Spot			

## OPTIONAL FEATURES

<b>Program Unit (Pendant)</b>	MA-627A
<b>Monitor Unit (Pendant)</b>	MA-628A
<b>Secondary Current Coils</b>	MB-400K, MB-400L, MB-800L, MB-800K
<b>DC Valve Power</b>	2 Amp, 5 Amp
<b>AC Control Transformers</b>	250 VA, 500 VA
<b>Disconnect Activation</b>	Rotary or Flange Mounted Handle, (except 4000CR)
<b>WeldLab/WeldNet</b>	Communication software (Bi-Directional)
<b>Electronic Pressure Regulator Output</b>	0-10V DC

Your Local Representative

*Spirit Of Innovation.*

**MIYACHI**  
**UNITEK™**

Corporate Office: 1820 S. Myrtle Ave. • P.O. Box 5033 • Monrovia, CA 91017-7133 USA  
Tel: (626) 303-5676 • FAX: (626) 358-8048 • E-Mail: info@muc.miyachi.com  
Internet: www.muc.miyachi.com • ISO 9001 Certified Company  
24/7 Repair Service: 1-866-751-7378

**EASTERN (USA)**

Sales Office:  
170 Cross Street  
Boylston, MA 01505  
Tel: (508) 869-0583  
FAX: (508) 869-0585  
E-Mail: eastsales@muc.miyachi.com

**MEXICO Sales Office:**

Pedro Rosales de Leon 7946-200  
Fraccionamiento Las Misiones  
Ciudad, Juarez, Chihuahua Mexico  
Tel: +52.656.623.2719  
FAX: +52.656.617.6058  
E-Mail: mxsales@muc.miyachi.com

**SOUTH AMERICA Sales Office:**

Av. Raimundo Pereira de Magalhães  
1720 – Edifício Via Fratelli, sl 163  
São Paulo – SP/Brazil 05145-200  
Tel/FAX: 55+ (11) 3834.7245  
Mobile: 55+ (11) 8389.8490  
E-Mail: sasales@muc.miyachi.com

**ASIA Sales Office:**

Unit D, 20/F, Infotech Centre  
21 Hung To Road  
Kwun Tong, Hong Kong  
Tel: +852 2833-6998  
FAX: +852 2833-6672  
E-Mail: asiapacific@muc.miyachi.com

**UNITEK EAPRO (Europe):**

Schootense Dreef 21  
NL-5708 HZ Helmond  
The Netherlands  
Tel: +31 492-54-22-25  
FAX: +31 492-53-62-22  
E-Mail: info@unitekeapro.com

Specifications subject to change without notice.  
Copyright© 2007 Miyachi Unitek Corporation. The material contained herein cannot be reproduced or used in any other way without the express written permission of Miyachi Unitek Corporation. All rights reserved.